

N°	Note de révision	Date	Signature	Vérifié
Rév				

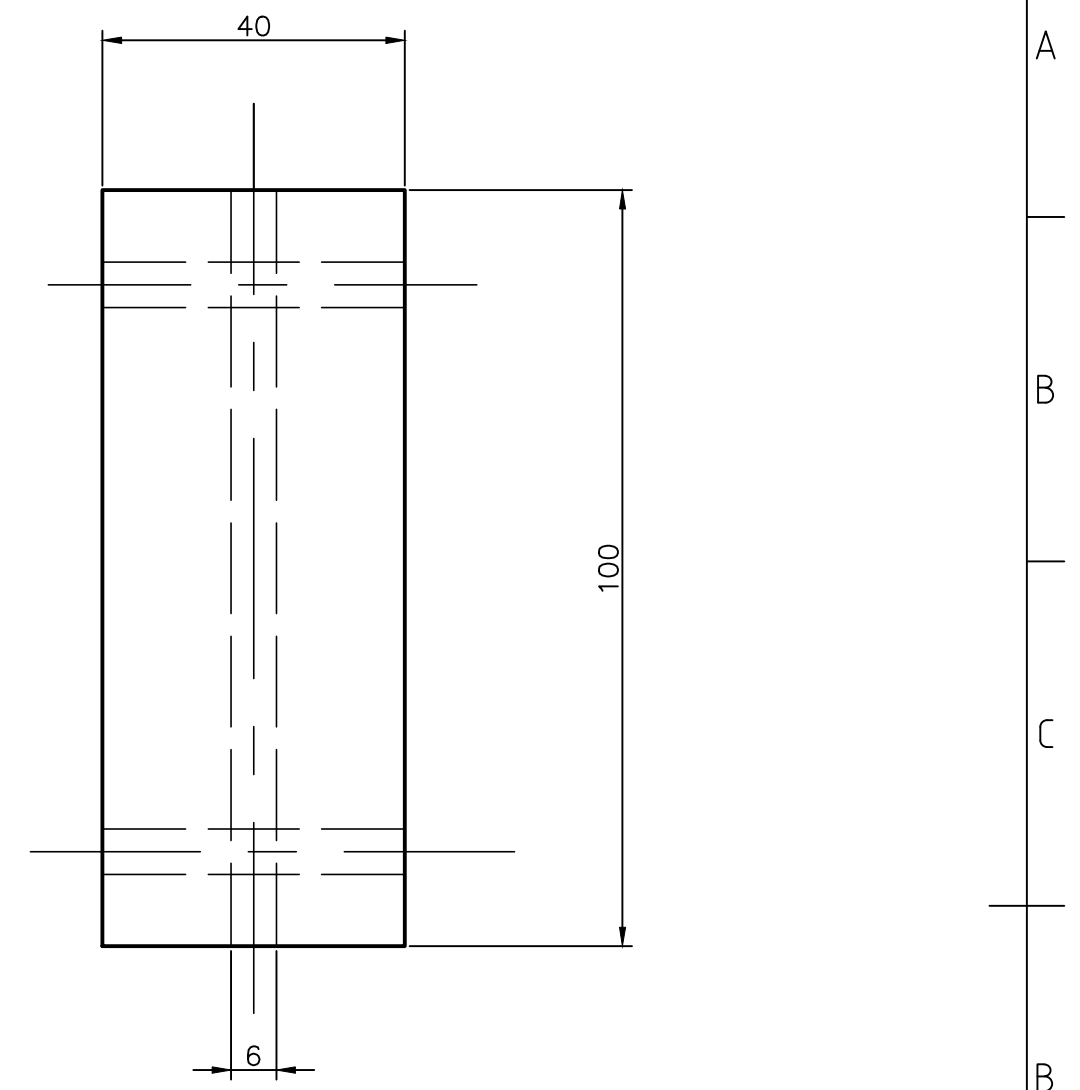

NOM FICHIER manufacturing metric.dwt	N° FSCM	FEUILLE 2	ECHELLE 1:1 mm
FORMAT	encastrement-A A		
DESS. 9/29/2016			
CONTR.			
APPR.			
REALISE			
REV	N° DESSIN	1 - Jadoul	
N° CONTRAT			