

Name	Material	Quantity	
Slot Fixed Wall 2	Aluminium 1.5mm	6	

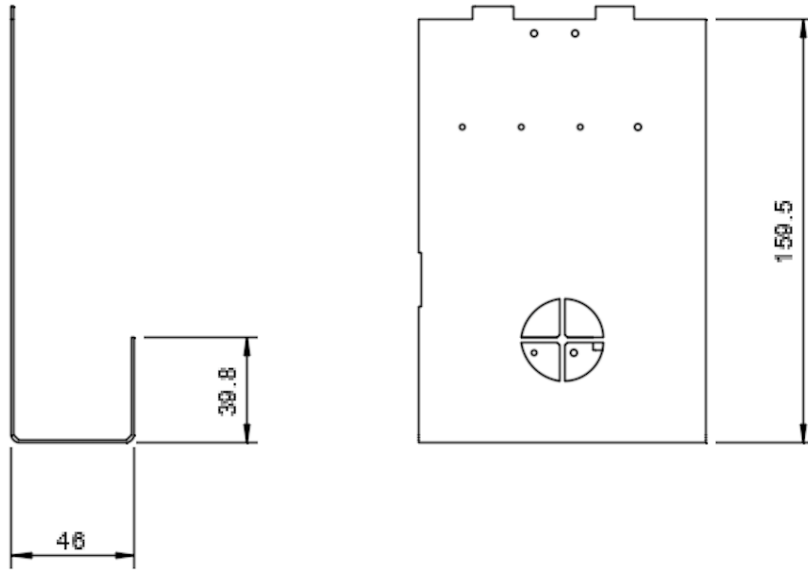
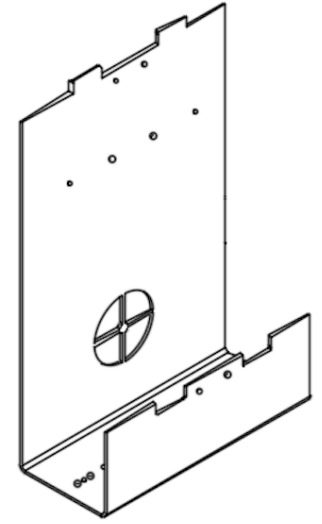

Dept.	Technical reference	Created by O.B	12/09/2023	Approved by
Aluminium 1.5mm				
		Title U. rev4 b5 Slot Fixed Wall 2		DWG no.
Rev.	Date of issue	Sheet		1/1